

Wine Master[®]

le temps d'être différent



INSTALLATION GUIDE USER GUIDE

Please keep

Wine PC15

INDICATIONS PLACED ON THE NAMEPLATE FOUND ON THE APPLIANCE

Model :
Serial number :
Purchase date :

* IMPORTANT: IT IS RECOMMENDED TO
NOTE THE SERIAL NUMBER AND TO WRITE
IT DOWN IN THE BOX ABOVE. IT WILL BE
NECESSARY FOR ORDERING SPARE PARTS

Ref

08/2009

CONTENTS

Introduction : <i>From the vine to the wine</i>	Page 3
1. General information	Page 4
1.1 Technical properties.....	Page 4
1.2 Required space	Page 5
1.3 Packet contents.....	Page 6
2. Some advice	Page 7
2.1 Conservation of the wine	Page 7
2.2 Exhaust air space	Page 7
2.3 The cellar	Page 8
2.3.1. Insulation	Page 8
2.3.2. Insulation of walls and ceiling.....	Page 9
2.3.3. Insulation of the floor.....	Page 9
2.3.4. Insulation of other elements.....	Page 9
3. Installation of the door	Page 10
4. Installation of the air conditioner	Page 13
5. Use of the air conditioner	Page 14
6. Service of the air conditioner	Page 15
7. The guarantee	Page 16
7.1 The legal guarantee	Page 16
7.2 2-year contractual guarantee	Page 16
7.3 Conditions applicable to the guarantee	Page 16
7.4 Guarantee exclusions and limits	Page 16

From the vine to the wine

In the past cellars were planned and built so that they could maintain a temperature not exceeding 14 to 16°C for a whole season unattended.

Nowadays not many cellars are capable of this.

Yet, a cellar that deserves this name, must be impervious against important temperature changes, be as humid as necessary and at the same time, be ventilated, dark and insensitive to vibrations.

That is why we have spent the last fifteen years, surrounded by specialists and passionate and demanding amateurs, projecting, developing, testing and producing thousands of air-conditioning systems for the conservation and ageing of wine.

If you follow our advice and adhere to our recommendations, your wines will be able to fully develop.

Before installing and using your WINEMASTER® FONDIS cellar air-conditioning, you must read the following instruction carefully.

If you have any questions, please contact us!

And so... even if several long years may be necessary until the wine fully develops its richness... the big and exciting day will come, when you can uncork your wine.

Carefully take the bottle... do not cut at the top right next to the neck of the bottle ... seize a beautiful cork-screw... draw the cork without causing vibration... to examine the «mirror»...

But that is a different story...

FONDIS AFTER-SALES SERVICE
Tél. +33 (0)3 89 37 75 00/Fax +33 (0)3 89 37 75 89
E-MAIL : contact@fondis.com

1. General information

1.1. Technical properties

Version : Right opening

Metal, painted white RAL 9010

Polyurethane-insulation 40 mm

Weight	65 kg
Capacity	Up to 15 m ³
Absolute dimensions (mm)	2000 x 720 x 254,5
Total weight	65 kg
Temperature regulation	Pre-set at 4 °C ; adjustable between 4 and 15 °C
Maximum outside temperature	35 °C *
Cooling capacity	450 W
Absorbed energy	390 W
Power supply	230 – 240 V
Coolant	R 404 a
Noise level - at 1m - at 3m	42 dB 40 dB

** As the cooling capacity reduces due to the outside temperature, the ability of the appliance to maintain a temperature of 12°C can suffer when the outside temperature rises to roughly 35°C.*

*Never the less, a **permanent temperature of 35°C in the exhaust air space must be avoided.** Such a high temperature must be reached during the summer season only (see §1.1 "Exhaust air space").*

1.2. Required space (mm)

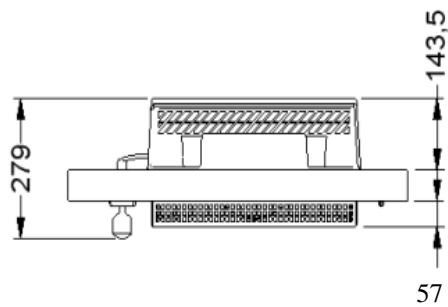
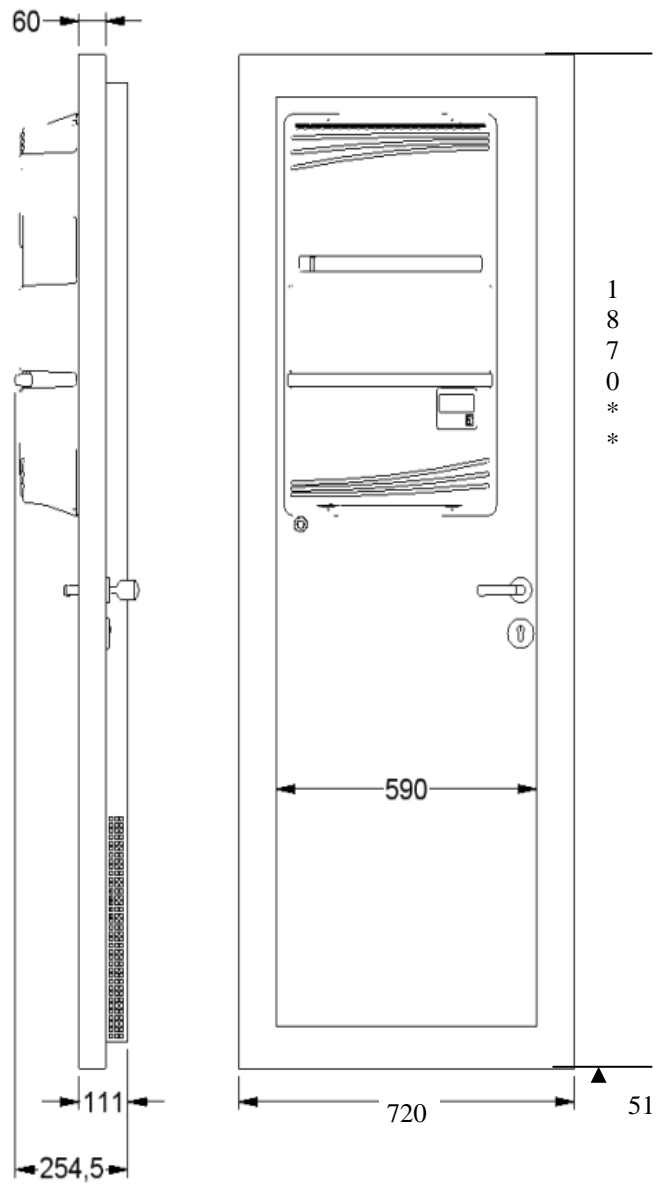
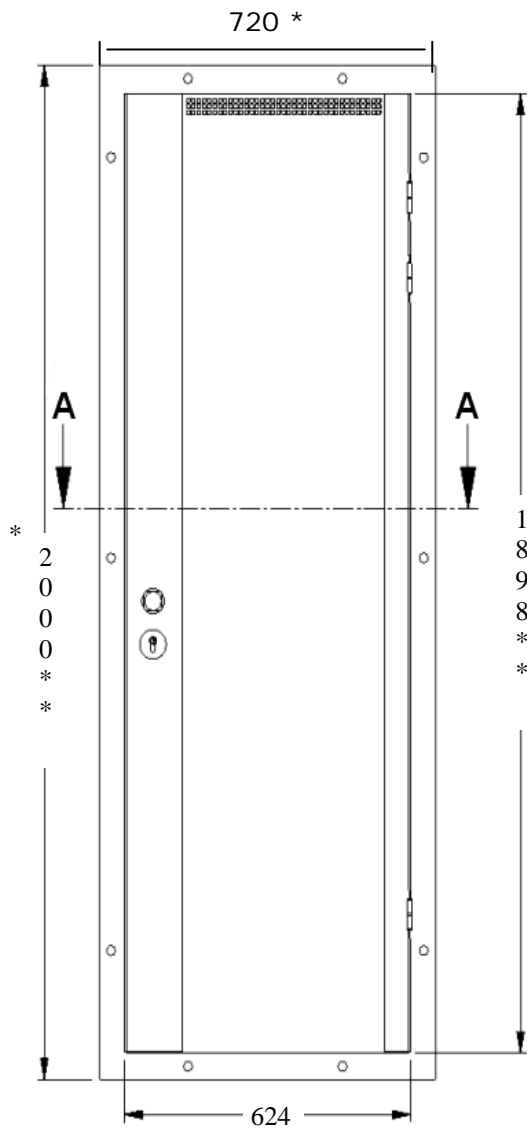

* Dimension extérieure

** Passage

A-A (0,06 : 1)

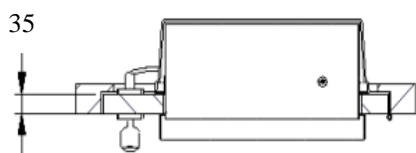

1.3. Packet contents

Packet 1

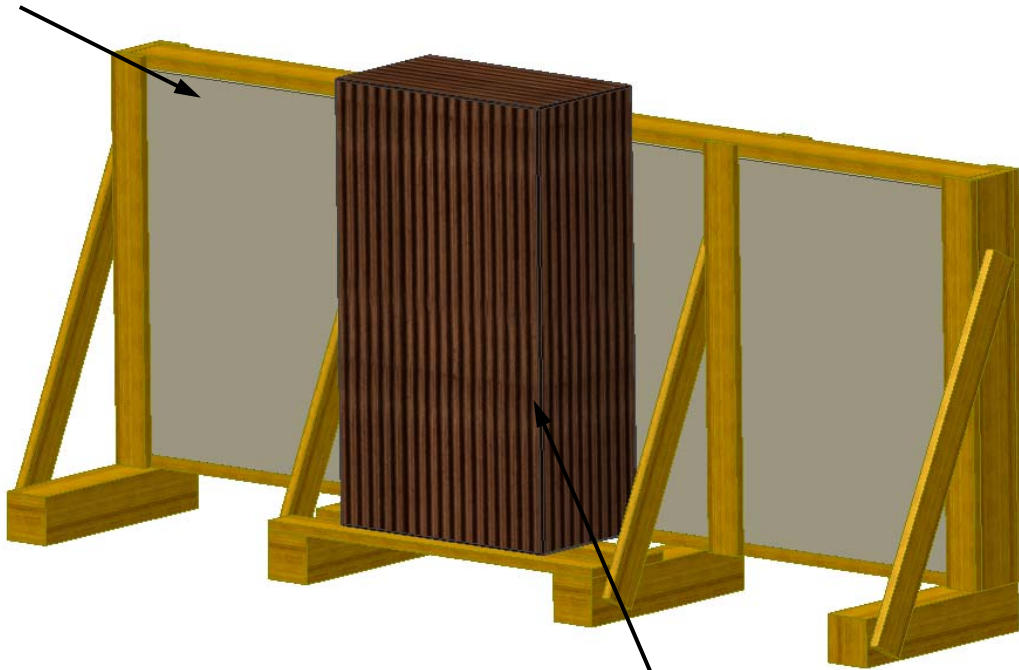

Packet 2

Packet 1 :

- 1 set door + frame + hood
- 1 set handle
- 1 roll edge seal
- 8 fixing screws + plugs
- 8 white plastic covers
- 1 cartridge of silicone
- 1 cylinder + keys set

Packet 2 :

Important !!! When you receive your packet, check the contents carefully.

2. Some advice

2.1. Conservation of the wine

The wine must have a place all to itself.

For the conservation and the ageing of the wine, the environment has to meet certain conditions.

The stability of the cellar temperature, more so than the temperature itself, is important for good conservation of the wine.

The central heating pipes and a boiler close by are great enemies of the wine.

A good cellar should be neither too dry nor too humid.

The effect of dry air is treacherous: it dries the cork, causes a considerable evaporation of the wine through the cork and makes the bottle leaky. Too much humidity favours the growth of mould on barrels and corks.

A humidity level of around 70 % is ideal, but for the wine, the humidity level can vary between 40 and 100 % without degeneration.

The cellar must be closed and protected against vibrations. The shelves or racks must be isolated from all possible sources of vibration and stand on the ground, rather than be attached to a wall which is more sensitive to vibrations.

In order to age, the wine has to be protected from the light. The cellar must therefore be dark and the use of light be limited to the bare minimum.

When these conditions are met, the wine will keep for a long time. The cellar will ensure a good maturation and an optimal ageing of the wine.

Wine is not as sensitive as is often thought, it must above all be protected from its most important enemies: sudden temperature changes, light ... and those who abuse it!

2.2. Exhaust air space

- The "hot" front of the WINEMASTER® must be inside a room.

The room, into which the exhaust air of the WINEMASTER® goes, must be well ventilated, so that the maximum and permanent temperature does not exceed 35°C, the ideal temperature being 20°C.

Attention, too little room inside the cellar can result in the hot air being emitted by the air-conditioning, being sucked in again. The outside of the appliance must not be installed in a dip or a space that is too small.

2.3. The cellar

2.3.1. Insulation

It is decisive for the WINEMASTER® to function well that adequate insulation of all the cellar walls contributes to a better stability of the temperature and humidity level.

The following table (choice of the insulation) serves to determine the necessary means and thickness of the insulation for an inside temperature of 12°C. These depend on the size of the cellar and the WINEMASTER model.

Continuity of the insulation :

The installation of the insulating elements must be done as follows: preferably by locating the edges of the panels into each other or by glueing the panels to each other so that a perfect continuity of the insulation is ensured.

This is very important as it prevents the penetration of warmth and humidity, which would interfere with the regulation of warmth and humidity.

IMPORTANT

The validity of the WINEMASTER®-guarantee is closely related to the strict observance of the values in the table "Choice of the insulation" for all the cellar walls including the floor, the ceiling and the door as well as to the perfect continuity of the insulation and an installation according to the instructions.

CHOICE OF THE INSULATION

MINIMAL THICKNESS OF THE INSULATION (mm)			
VOLUME OF THE CELLAR (m ³)	EXPANDED POLY-STYRENE $\lambda = 0.044\text{W/m}^\circ\text{C}$	EXTRUDED POLY-STYRENE $\lambda = 0.030\text{W/m}^\circ\text{C}$	POLYURETHANE FOAM $\lambda = 0.025\text{W/m}^\circ\text{C}$
3	45	30	25
6	65	45	40
8	80	55	45
10	100	65	55
12	100	70	60
14	110	70	60
15	110	80	70

CHARACTERISTICS OF THE INSULATIONS

Heat conductivity λ : Unit W/m.°C

- This is a characteristic of the insulant itself. It describes the capacity of the material to conduct heat. The lower the coefficient, the better the insulating capacity of the material.

- Heat resistance R : Unit m².C/W

- This is a characteristic of the insulating panel. It depends on the coefficient and the thickness of the insulation.

$$R = \frac{\text{Thickness in meters}}{\lambda}$$

It describes the capacity of the thickness of the insulation to reduce heat transfer.

The higher the coefficient R , the better the insulation.

2.3.2. Insulation of walls and ceiling

Choice of the insulation panels.

The producers offer insulation panels of several kinds :

= **insulation only**

- **"complex" insulations** : The insulation is coated (plaster, mineral...),
- **sandwich panels**: the insulant is covered on both sides with a layer of wood or plaster.

The facing of the panels is important: it protects the insulant against shocks and ensures its durability.

Do not use insulations made of mineral fibres (glass wool, rock wool, etc...), because they can absorb humidity and lose their insulating capacity.

Protection against rodents

Certain insulants can be attacked by rodents (mice, rats...). It must therefore be guaranteed that the cellar walls provide no openings through which the rodents can reach the insulation.

These insulations are covered with a protective layer on the inside of the cellar.

Polyurethane is an insulant, which due to its chemical composition, is not attacked by rodents.

2.3.3. Insulation of the floor

The cellar floor must be strong enough to carry the shelves and the stored wine. For this part an insulation must be chosen, which provides sufficient resistance to pressure.

The producers indicate in their documentations if the insulating materials are appropriate or specially designed for floors.

Resistance to perforation (in particular by the feet of shelves) is obtained :

- by using "complex" insulation panels, which are covered on the upper side with a sufficiently resistant plate.
- by facing the insulant with chipboard (thickness ca. 15 mm) or with another adequate cover (floor boards or tiles for example).

2.3.4. Insulation of other elements

Do not put wine cupboards or freezers in the cellar, because they produce heat.

All sources of heat in the cellar, such as central heating pipes, must be insulated.

3. Installation of the door

Tools

1. CROSS HEADED SCREW DRIVER
2. SPIRIT-LEVEL
3. SLIP-JOINT PLIERS
4. MEASURING TAPE



Dimensions of the wall opening :

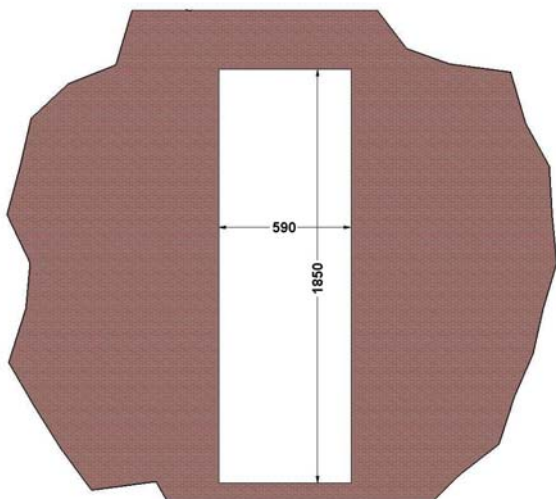

With threshold

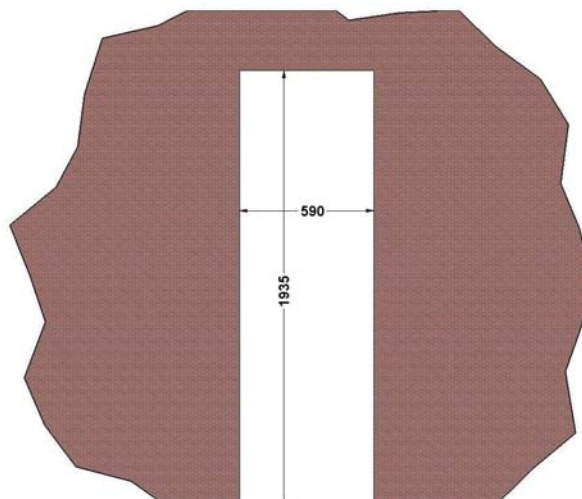

Without threshold

MAKE SURE THE EDGES AND SURFACES OF THE OPENING ARE CLEAN AND SMOOTH.

1. Apply the edge seal to the frame

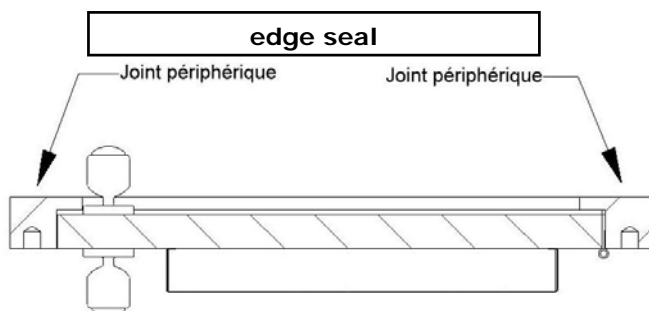

Fit the frame into the wall opening.

2. Fix the door-jamb at the side of the hinges horizontally by using a spirit-level, as indicated below.

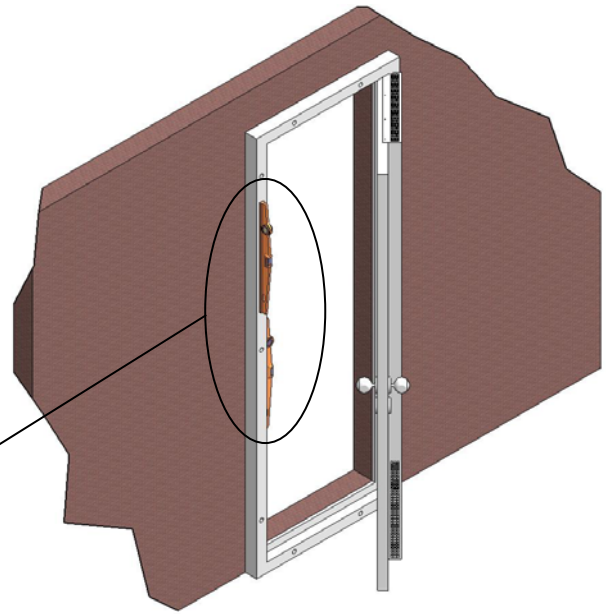
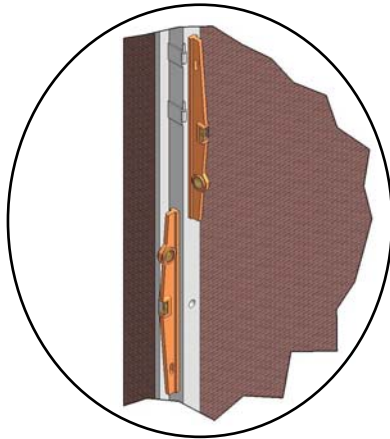

3. Install the door on the hinges, then after having fixed the hood on the door, adjust the door-jamb and the hinges.

4. The door must fit precisely into the frame in order to ensure optimal impermeability. Readjust the door-jamb and the hinges if necessary.

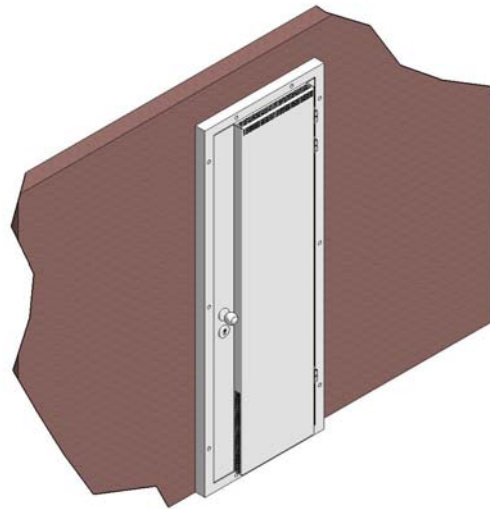

5. Check the right-angledness of the installation and then fix the other sides of the frame.

If necessary you can use glue in addition to the screws. If the frame is to be fixed to dry walls, glue may even be indispensable.

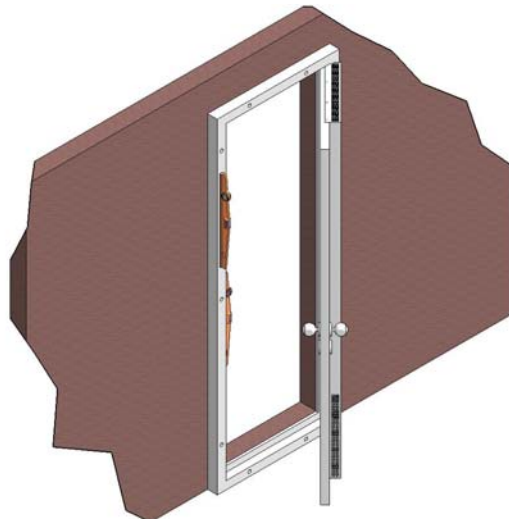

Right-angledness of the installation - a regular border is important.

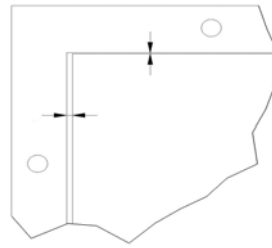

6. Seal the space between the frame and the wall with silicone or acryl.

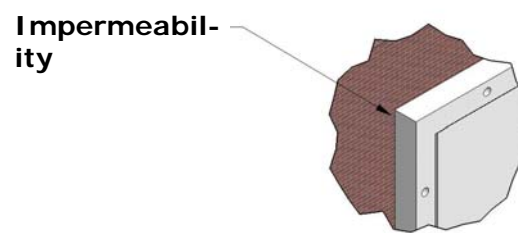

7. Cover the mounting holes with the plastic covers provided for this purpose.

8. Remove the protective film from the door.

4. Installation of the air conditioner

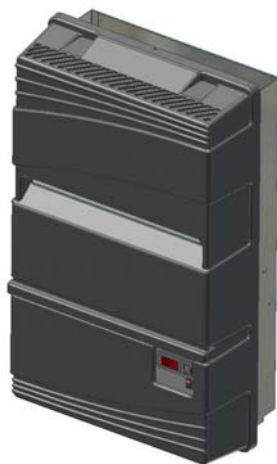

1. Pass the power cable through the cable bushing under the door opening situated on the left side.

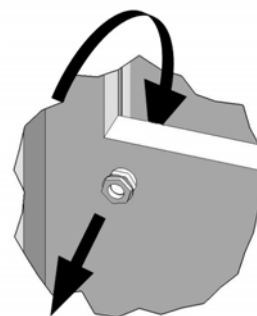

2. Place the air conditioner in the door aperture

3. Check the height of the appliance and fix it to the door with the 4 thread forming screws and the rings. The top 2 first, then the bottom ones.

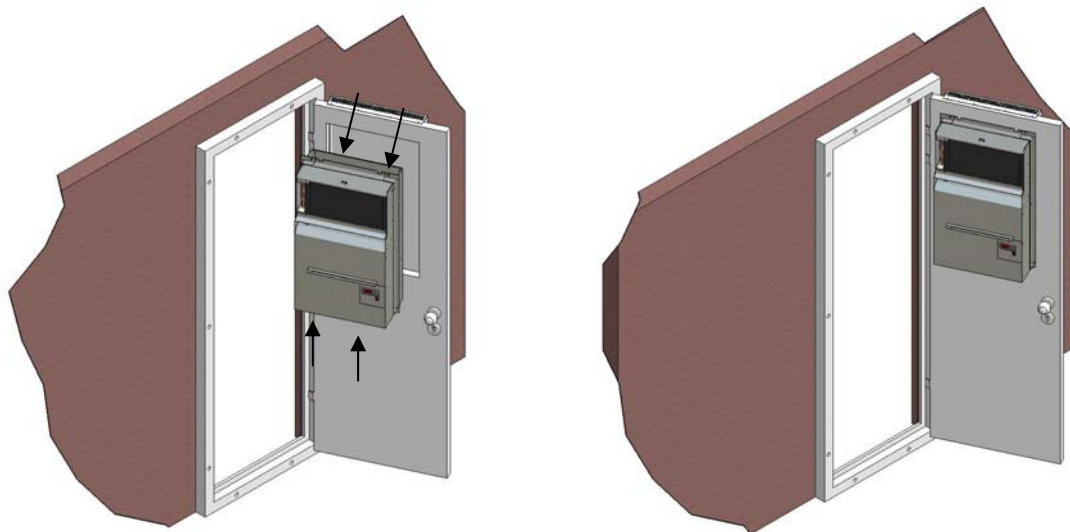

4. Put the hood on and fix it with the corresponding screws, 2 at the top and 2 at the bottom without tightening them.

The thermostat is visible through the opening in the hood.

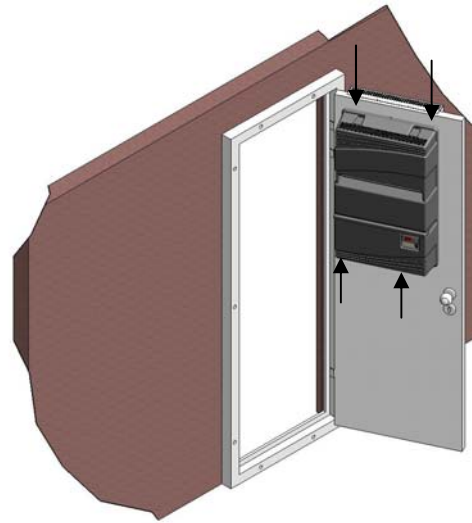

5. Connect the plug to the mains.

5. Use of the air conditioner

Use the switch (5), to switch the air conditioner on or off.

• Temperature regulation :

The temperature can be regulated between 4 and 15°C.

It is pre-set to 4°C at the factory.

The recommended temperature for optimal wine storage is 12°C.

◆ Thermostat regulation : (indispensable when bringing the machine into service for the first time)

- Push the button ' SET ' (3). The display (1) will flash and indicate the programmed temperature.
- Push the top button (2), in order to increase the temperature in the cellar.
- Push the lower button (4) to reduce the temperature.
- Push again ' SET ' (3) to validate the required temperature.

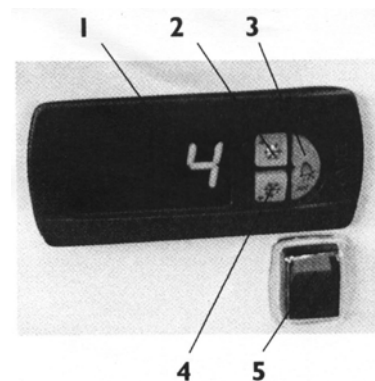

**GREEN INDICATOR
TOR LIGHTING**



**LIGHTING OF THE KEY LIGHT OR
ON**



**RED INDICA-
ON**

**GREEN INDICATOR
TOR LIGHTING**



**LIGHTING OF THE KEY LIGHT OR
ON**



**RED INDICA-
ON**

The thermostat display always indicates the temperature of the air in the cellar, not the temperature of the wine.

If you want to measure the temperature of the wine, the best way to do this is to put a thermometer into a glass of water for a few hours in the middle of the room.

- Checking the installation :

For an optimal function of the air conditioner, you have to ensure the installation is impermeable.

Therefore, check to see if the door closes, so that it is completely tight.
Also check the impermeability of the frame against the wall.

- Function of the compressor :

The compressor starts and stops with an interval of $\pm 2^{\circ}\text{C}$.

This means, when the thermostat is set at 12°C , the temperature can rise to 14°C , before cooling starts again.

The compressor stops every hour for 7 minutes in order to defrost the unit.
Any condensation evaporates automatically.

If the door is left open for too long by mistake and the compressor works more than necessary, the excess water flows away through the overflow.
This can also happen when the cellar is not impermeable enough.

It does not happen if the air conditioner is correctly used and installed.

6. Service of the air conditioner

- Service IMPORTANT !!!

It is vital to check the dust filter once a month and to replace it if necessary but it must be changed at least once a year.

If the filter is dirty, the air conditioner can be severely damaged.

How to change the filter ?

1. Take the filter cover (E) off.
2. Pull the flap in order to pull out the filter.
3. Put in the new filter.
4. Reinstall the cover.

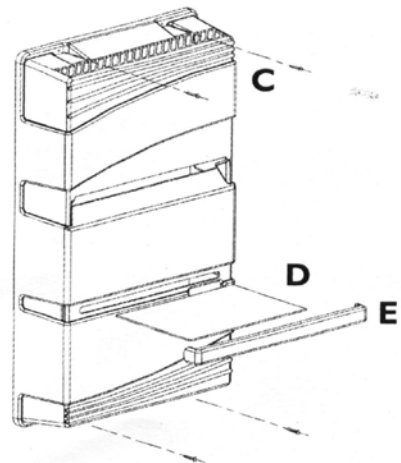

7. The guarantee

7.1. The legal guarantee

The contractual guarantee is, to the advantage of the buyer, not exclusive of the legal guarantee for hidden mistakes and defects, in accordance with the conditions of art. 1641 ff of the Civil Code.

7.2. 2-year contractual guarantee

The air conditioner has a 2-year guarantee for all defects of production.

During the term of the guarantee, FONDIS replaces all parts that are demonstrably defective.

In case of a power failure, FONDIS replaces all defective parts, which were damaged due to the intervention of the dealer or his representative.

Should the cooling fail, FONDIS is entitled to demand that the appliance be returned to the factory for repair. The material has to be packed and ready to be collected by a carrier of FONDIS.

The repair works have to be carried out in accordance with the written agreements of the FONDIS after-sales service.

7.3. Conditions applicable to the guarantee

The contractual guarantee applies to all appliances that were installed and used according to the "Instructions for installation and use". Condition for the applicability of the guarantee is the presentation of the invoice from the purchase or a copy thereof.

7.4. Guarantee exclusions and limits

The guarantee is NOT VALID in the following cases :

- *The insulation of the cellar and the installation was not carried out in accordance with the presented instructions.*
- *The failures are due to negligence, bad servicing, wrong or inappropriate use of the air conditioner.*
- *The aim of the exchange of spare parts or their reparation within the guarantee cannot be to prolong the guarantee.*
- *The service information was not supplied to the after-sales service.*

FONDIS SA cannot under any circumstances be held responsible for the direct or indirect consequences of an incorrect function of the air conditioner. The guarantee applies exclusively to the product supplied by FONDIS S.A.

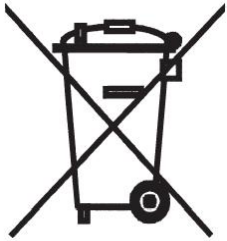

The European Community, which attributes great importance to the protection of the environment and waste treatment, has established the Directive 2002/96/EC on waste electrical and electronic equipment (WEEE).

According to this norm, the products have to be marked with crossed out rubbish bin.

This symbol means that the product **cannot under any circumstances be disposed of as household waste.**

It has to be given to a special collection point for processing, revaluation and the recycling of waste electrical and electronic equipment.

By following this directive, you make a gesture to the environment and contribute to the protection of the natural resources as well as to the protection of human health.